

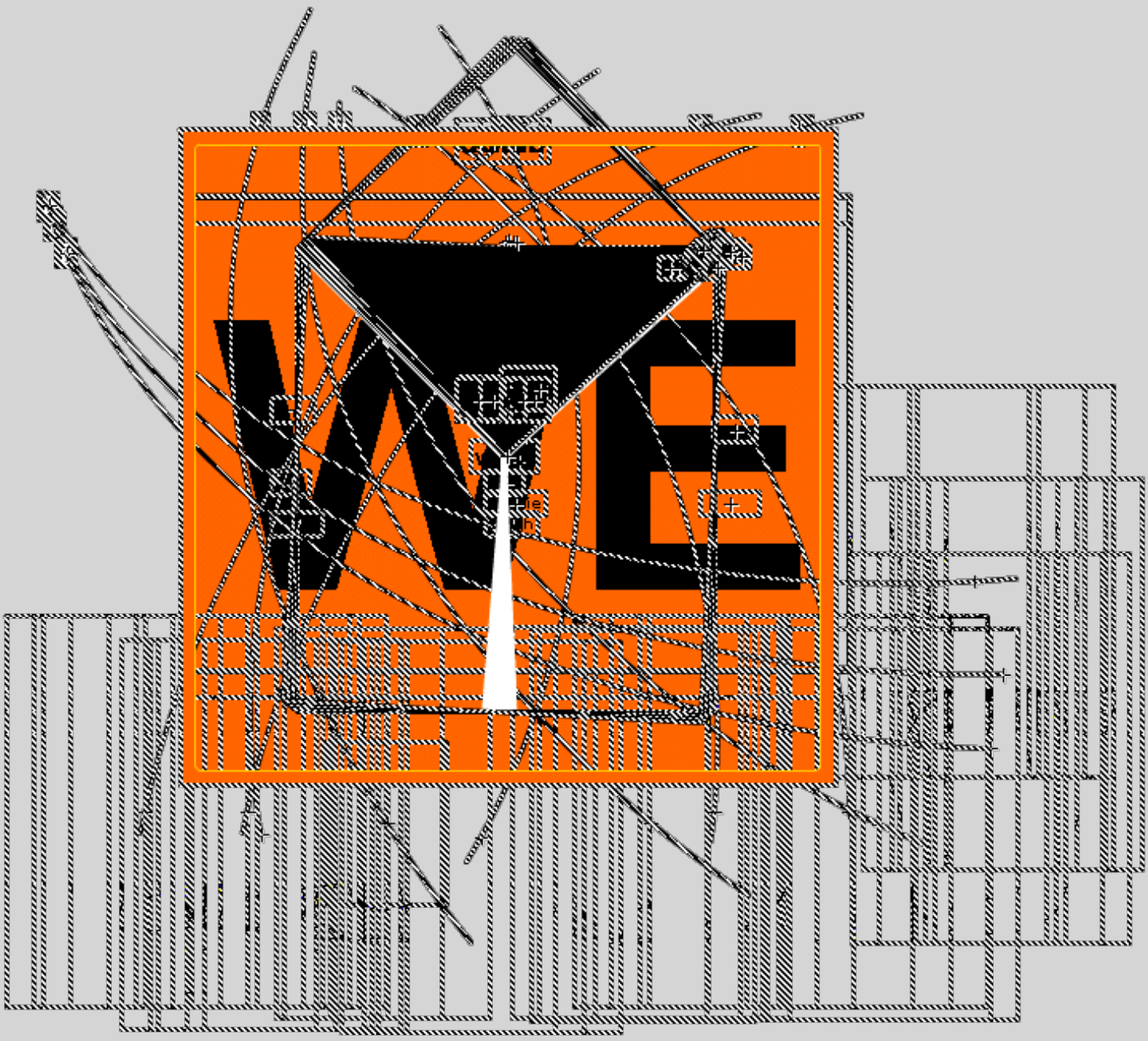

Versuche: 18

**The Dreamlife of Letters:
Frozen GIFs
[c. 1999]**

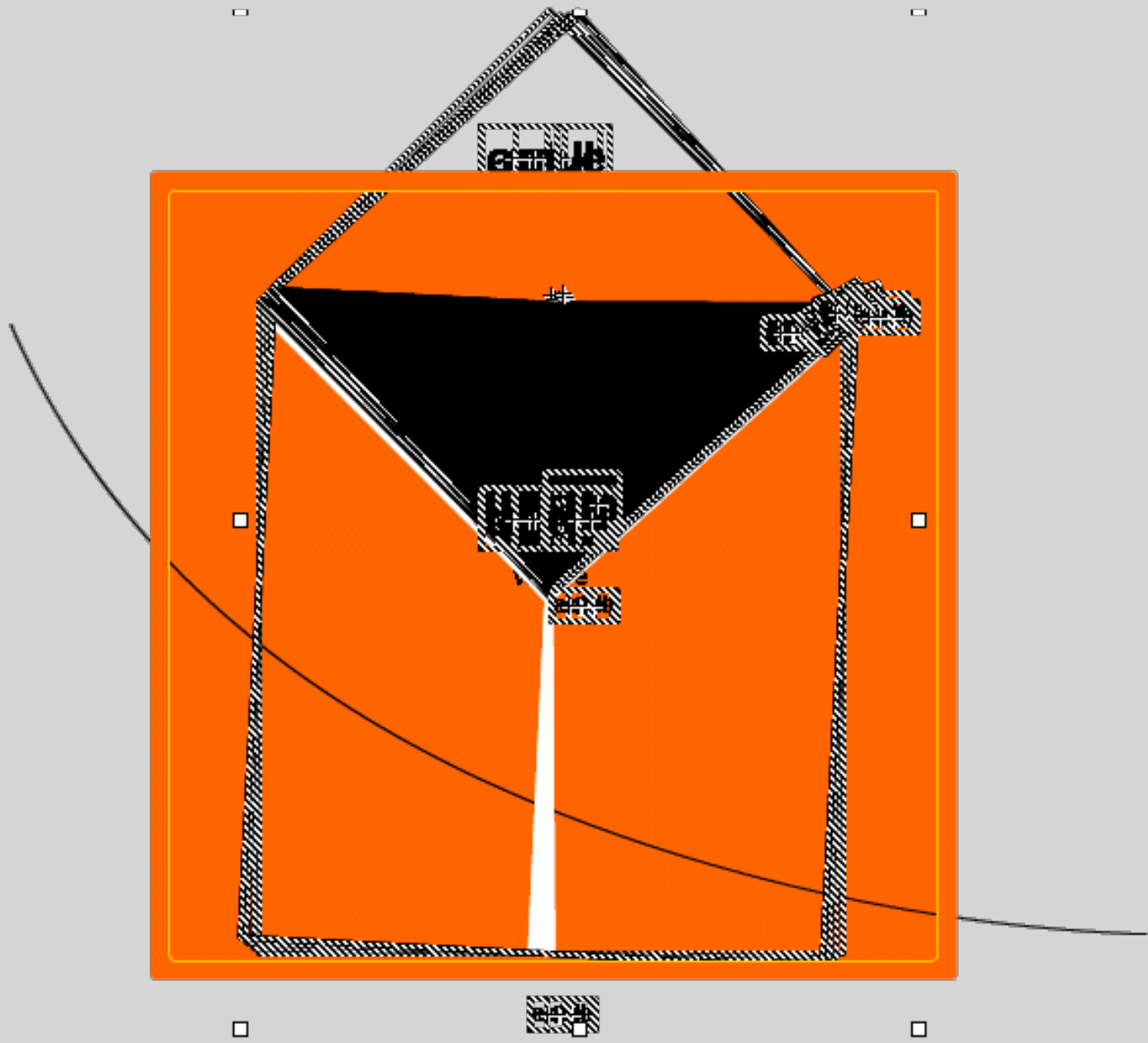



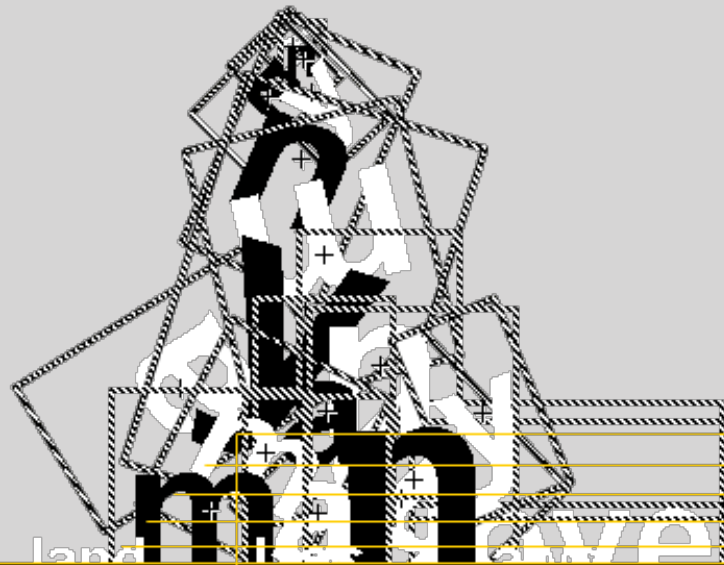

lives lo+ves

love

+
+
+
+
+
+
+
+
+
+

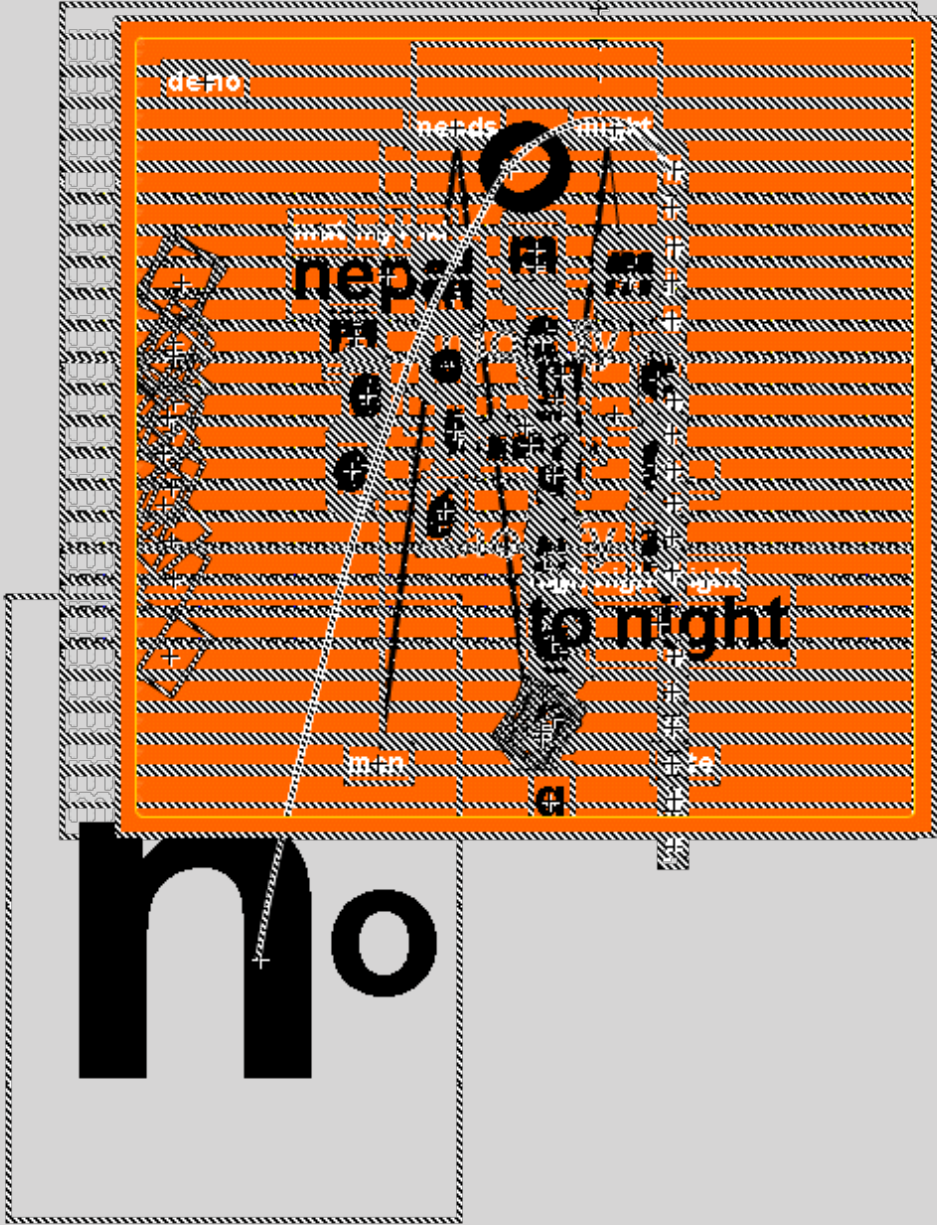

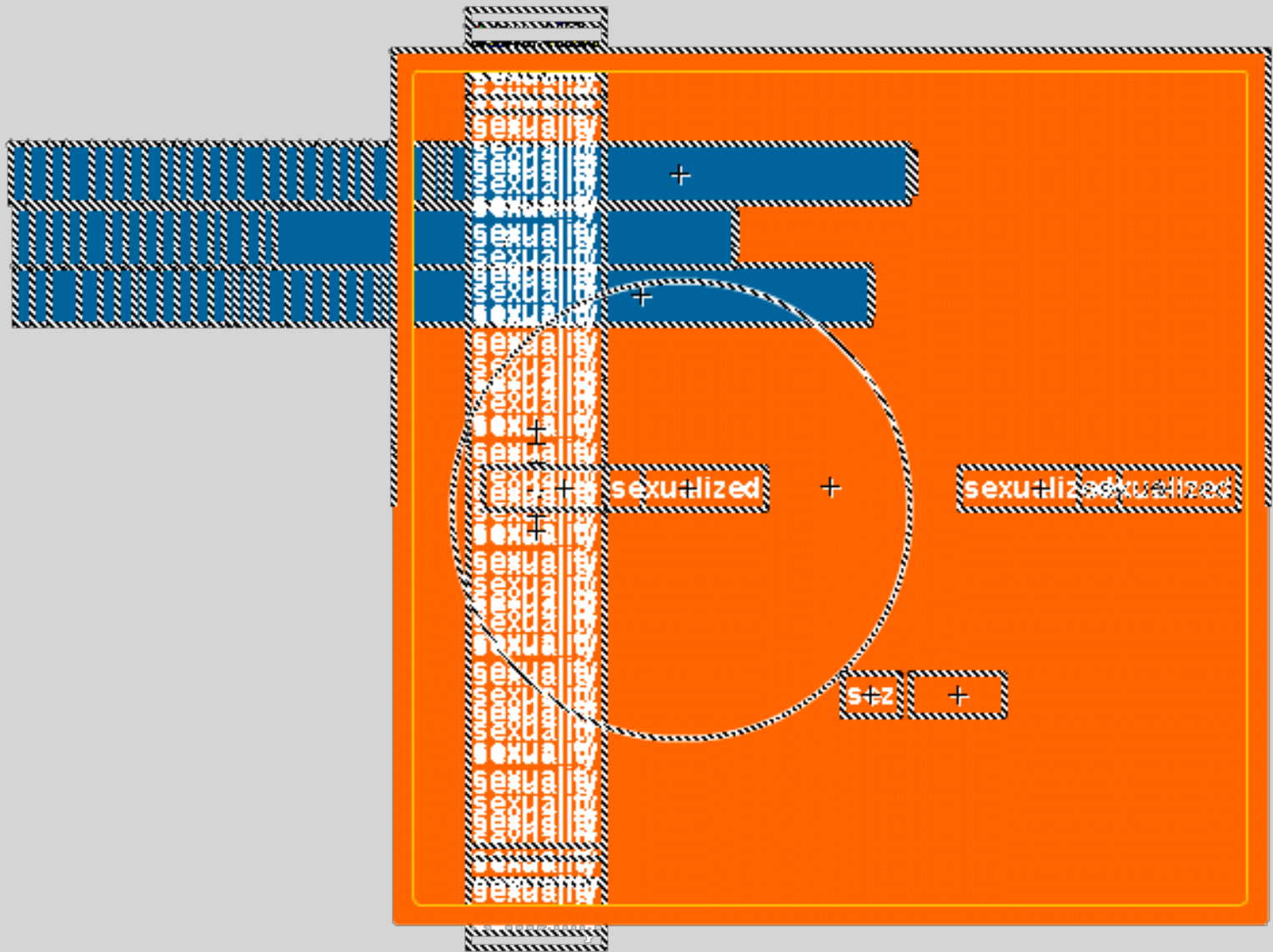

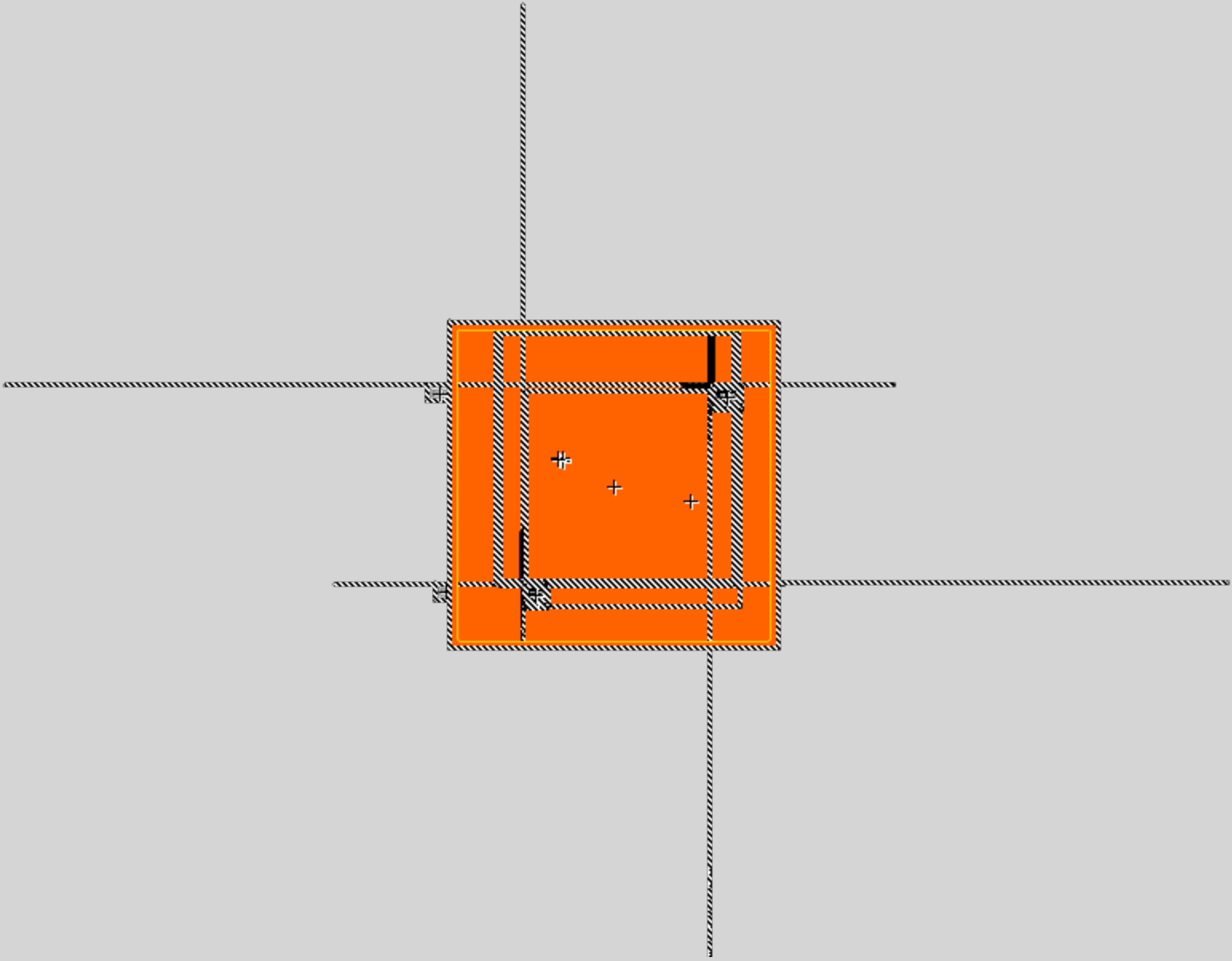

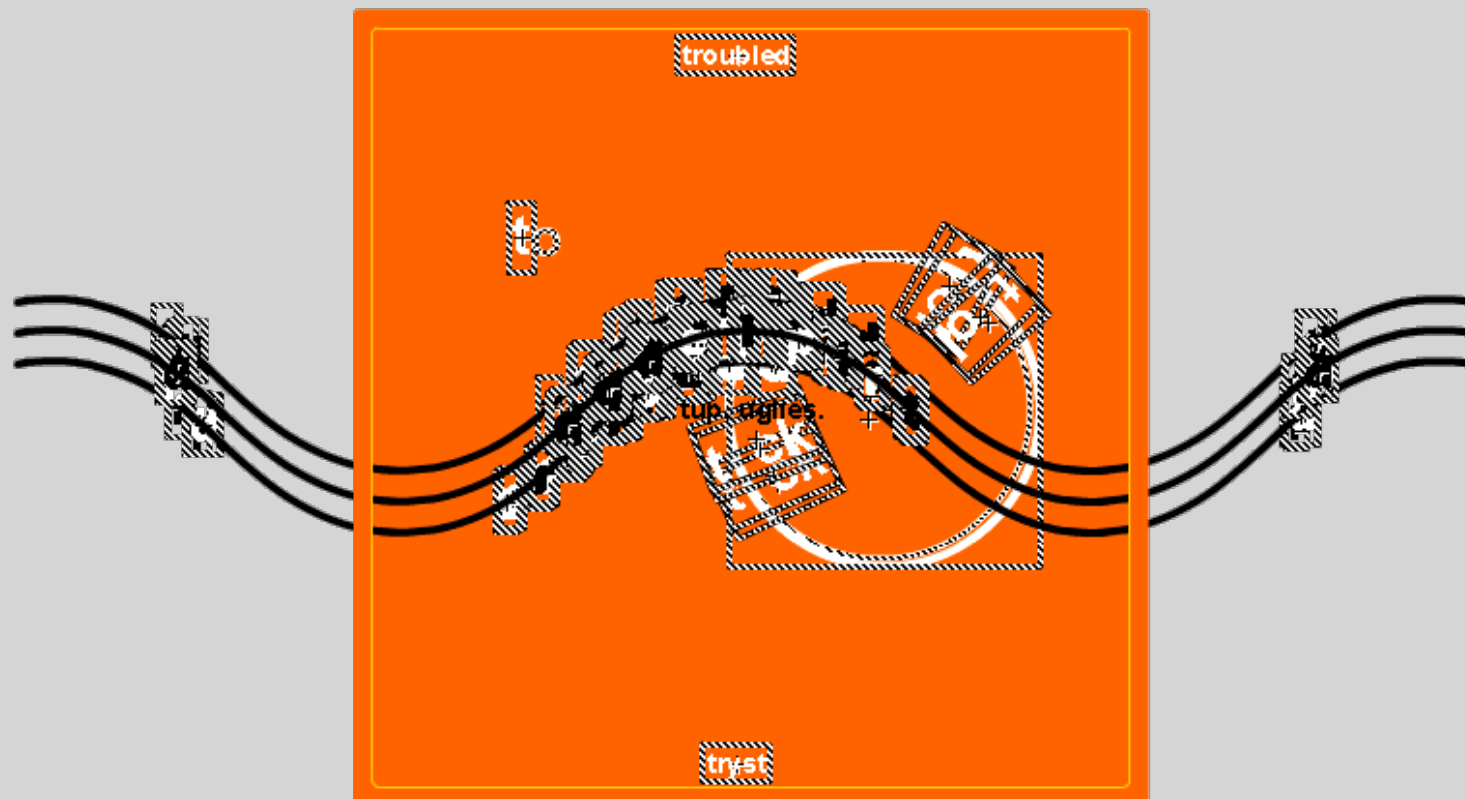

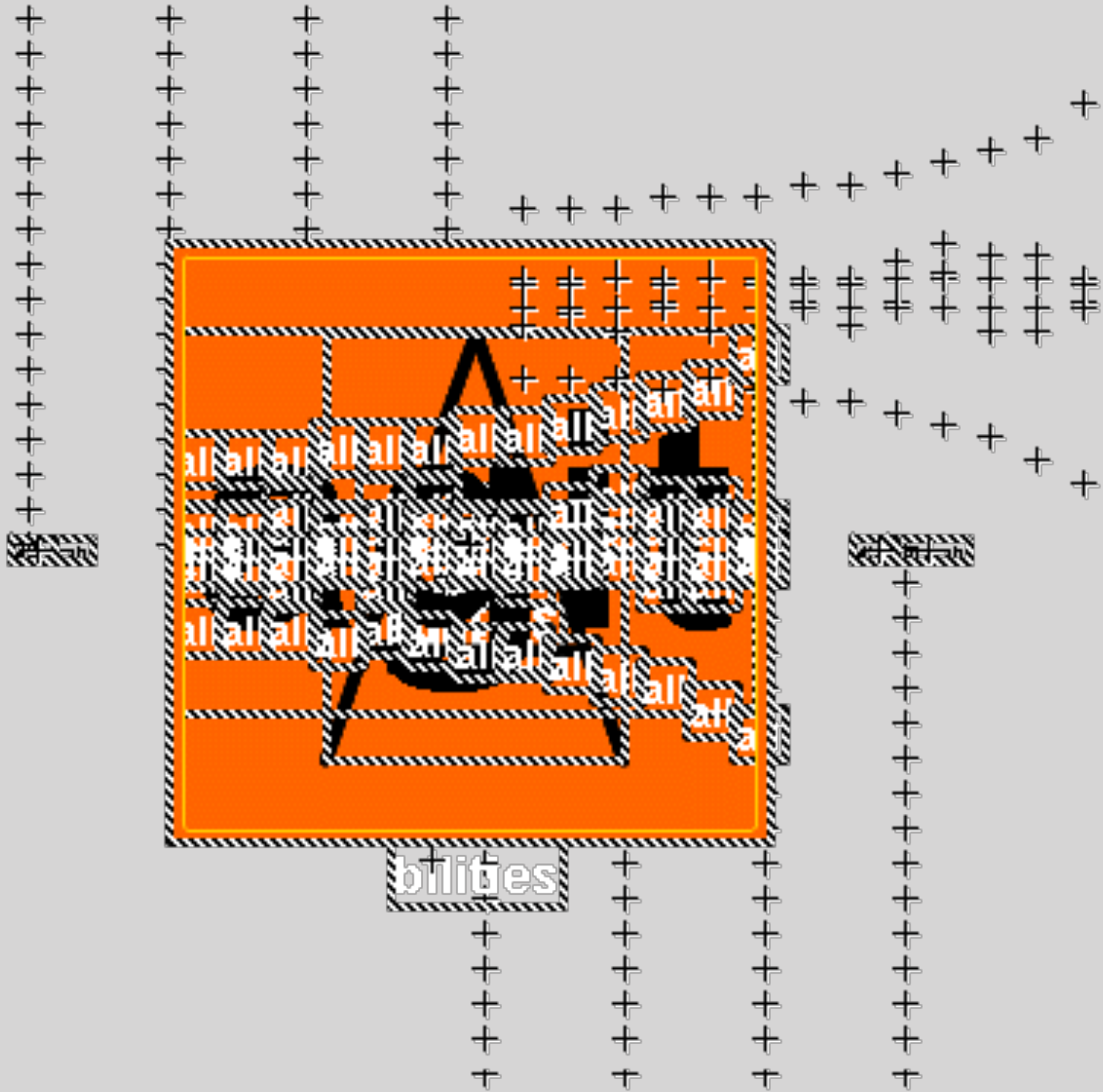

főlégi:

főlégi:

fontos

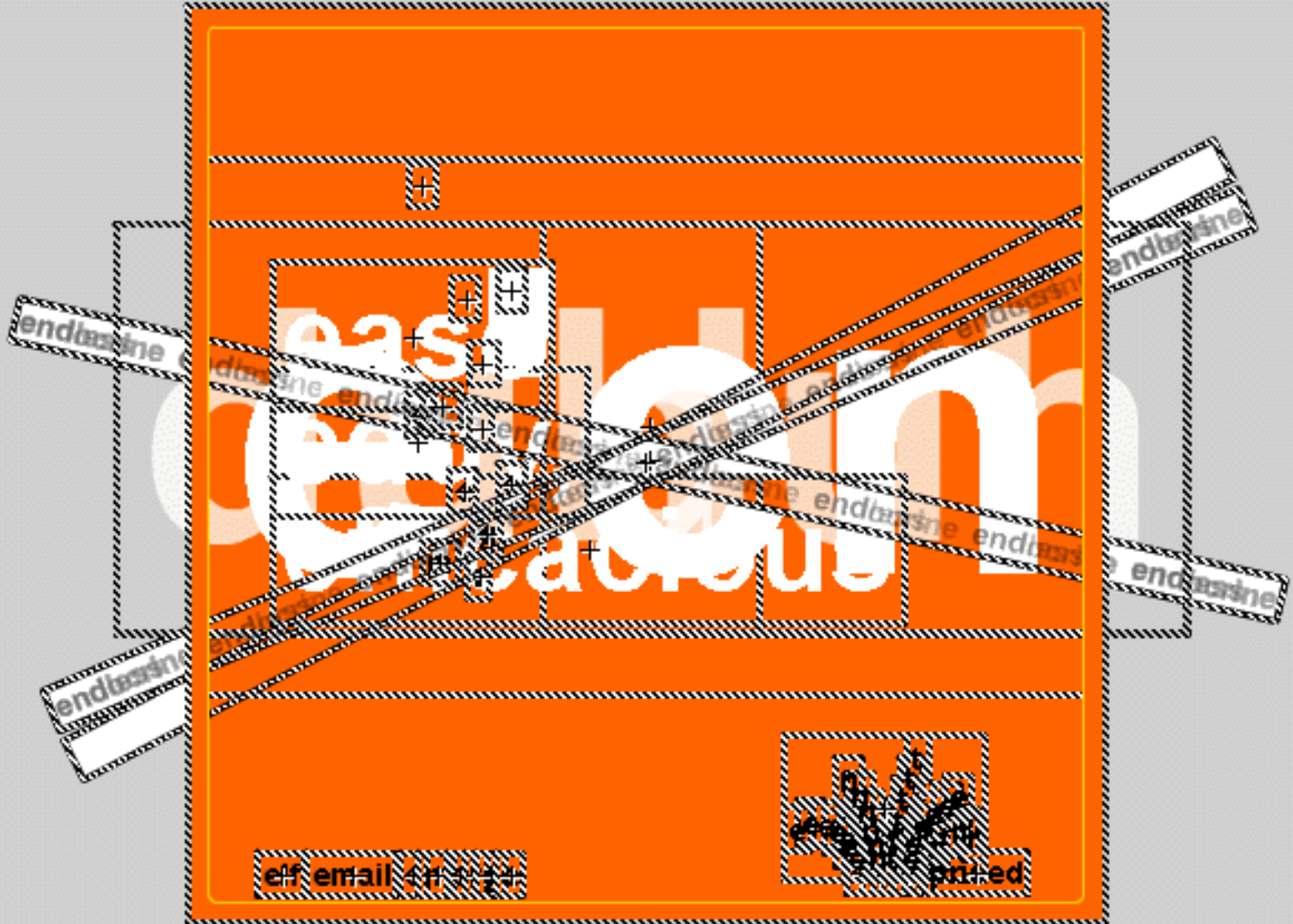



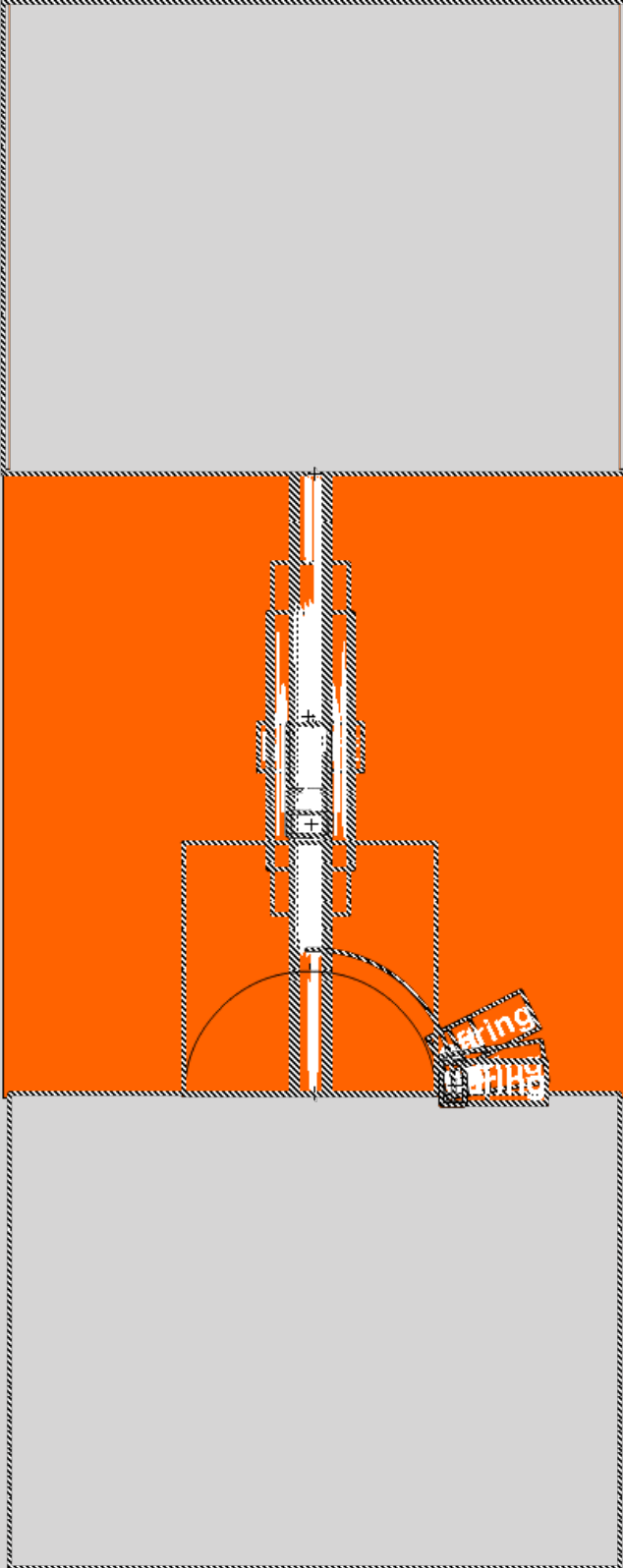

amend

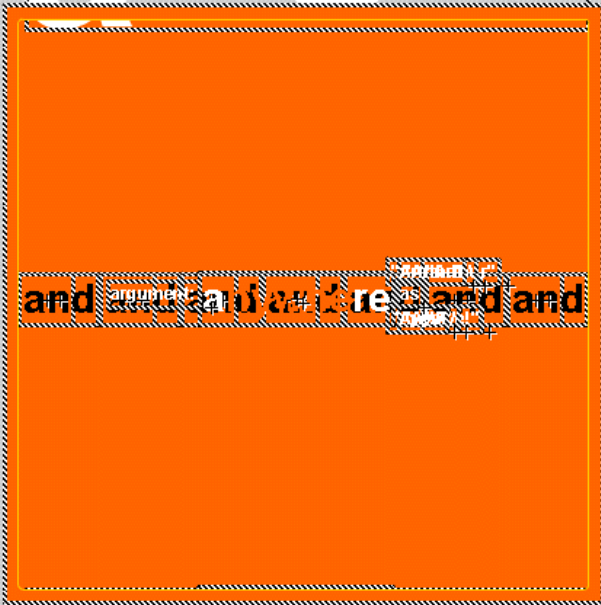

and and and re and and

Amur
Ave!

amend

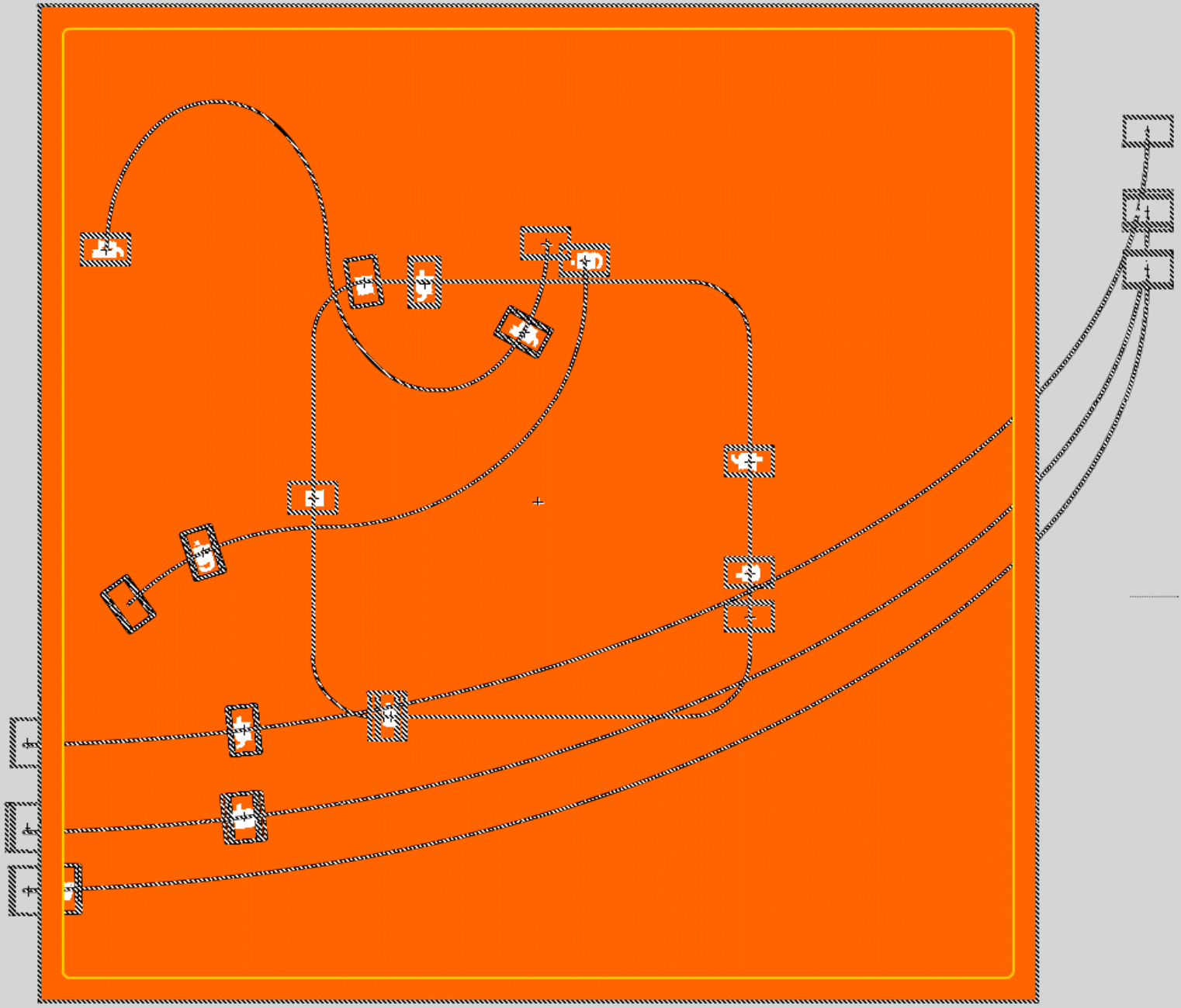

unconscious
under
conscious
um um

uis
uis